

# TRACK 48V : AANSLUITINGSSCHEMA'S

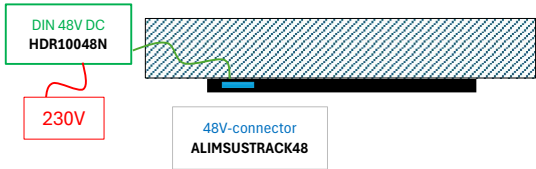

Betonnen plafond.

Externe 48V DC voeding op DIN-rail,  
Connector in rail (L +/-15cm).

A

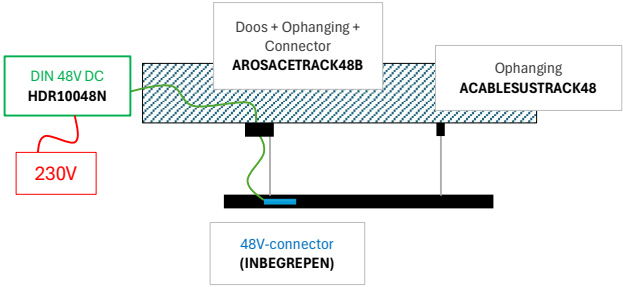

Betonnen plafond.

Externe 48V DC voeding op DIN-rail,  
48V driver in rail (L +/-15cm).

B

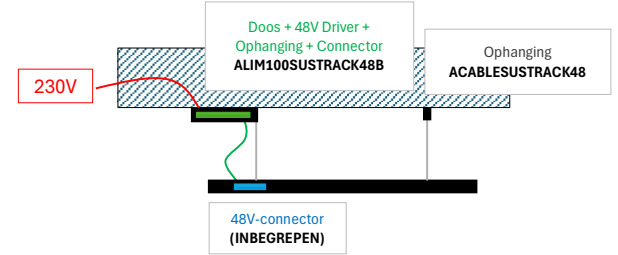

Betonnen plafond.

230V aansluiting in doos met 48V driver,  
Aansluiting in rail (L +/-15cm).

C

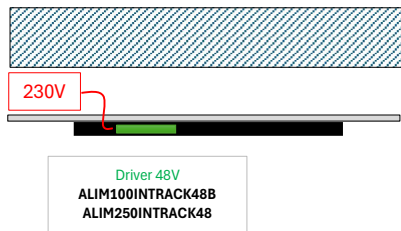

Verlaagd plafond.

230V aansluiting in verlaagd plafond,  
48V driver in rail (L +/-30cm).

D

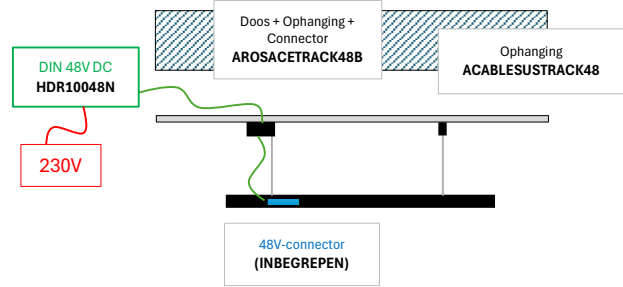

Verlaagd plafond.

Externe 48V DC voeding op DIN-rail,  
Connector in rail (L +/-15cm).

E

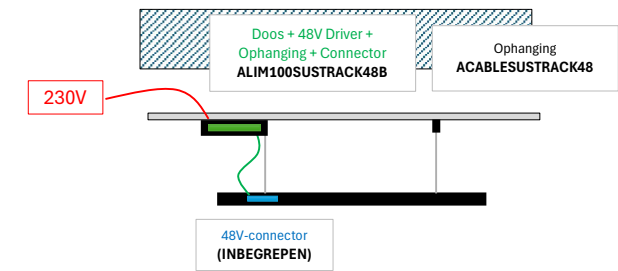

Verlaagd plafond.

230V aansluiting in doos met 48V driver,  
Aansluiting in rail (L +/-15cm).

F

TRACK 48V : SCHEMA'S VOOR DALI DIMMEN

ALGEMEEN DALI DIMMEN, ZONDER DE MOGELIJKHEID OM ARMATUREN TE GROEPEREN.

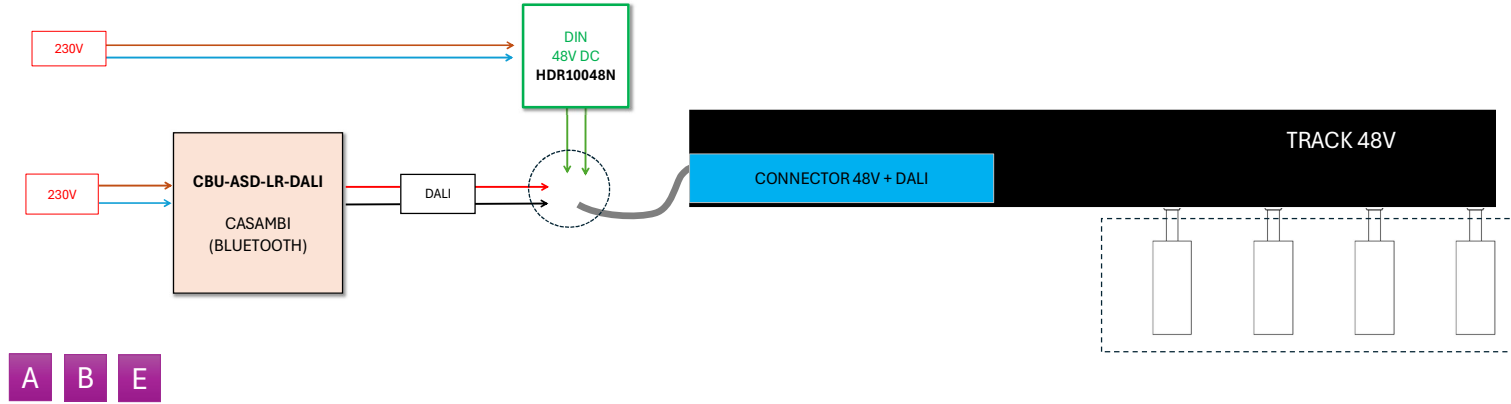
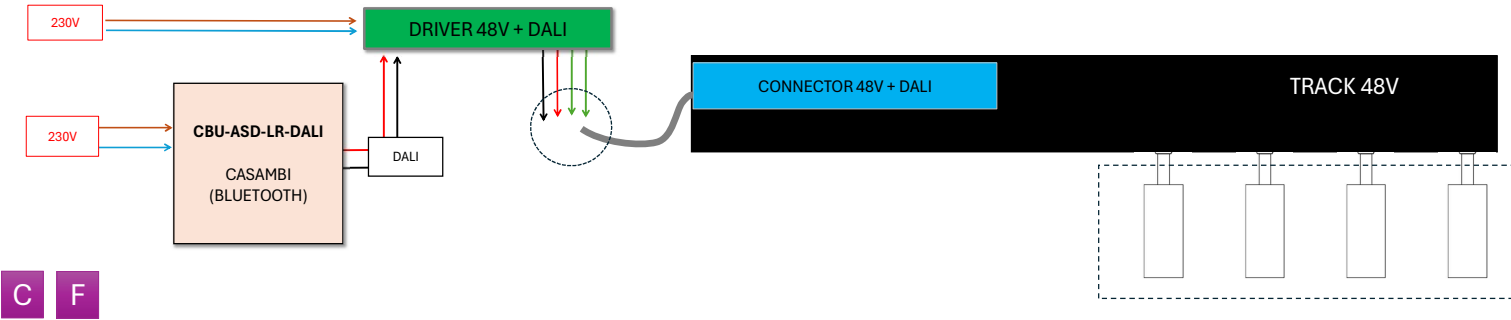
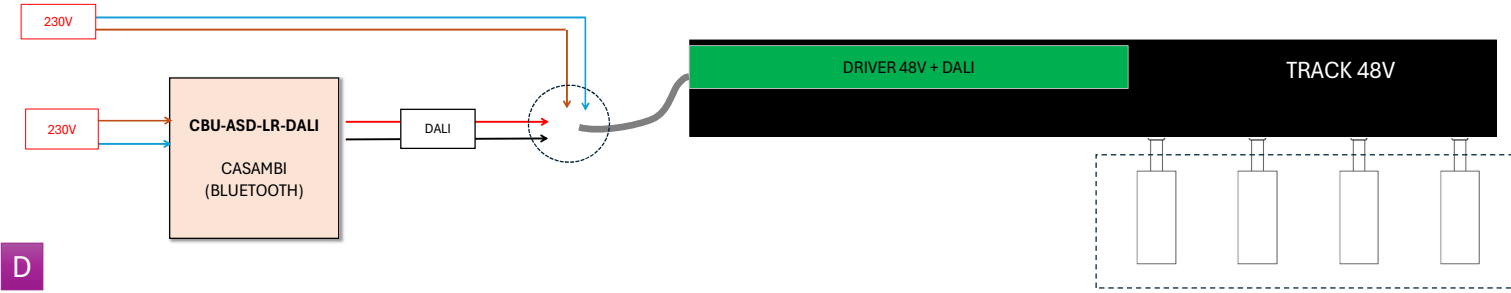

TRACK 48V : SCHEMA'S VOOR DALI DIMMEN  
DALI DIMMEN **MET** DE MOGELIJKHEID OM ARMATUREN TE **GROEPEREN**.

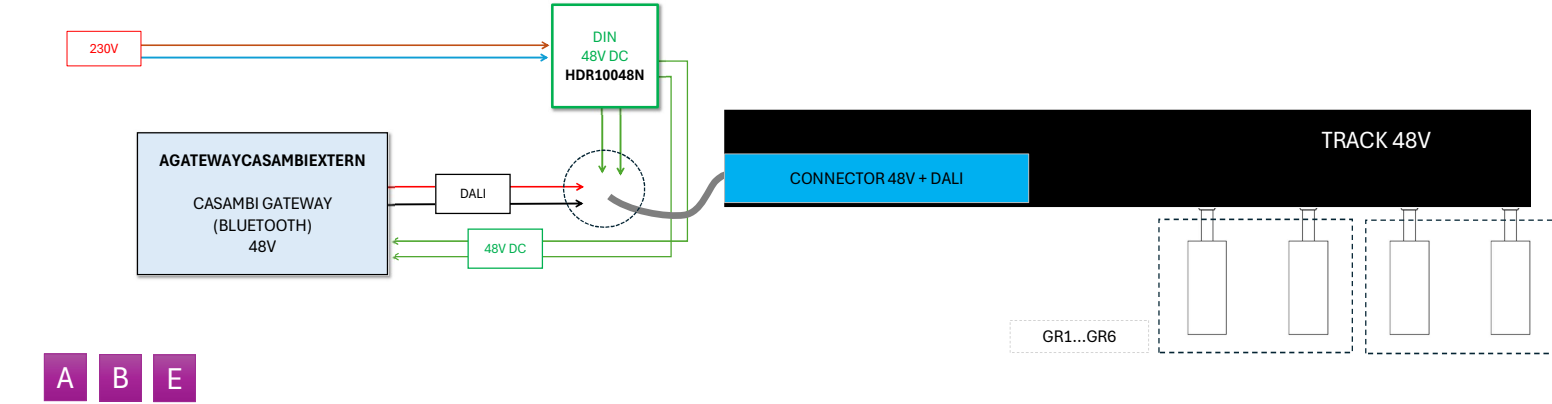
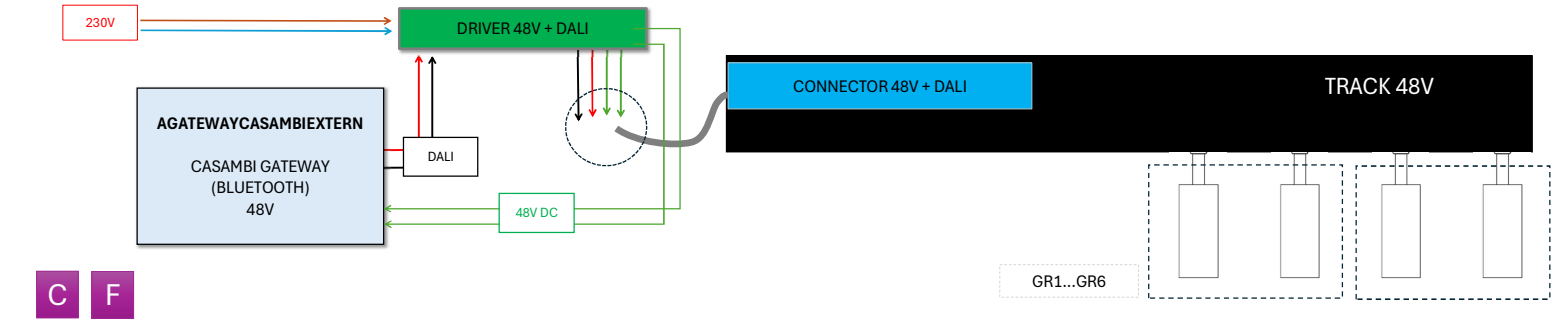
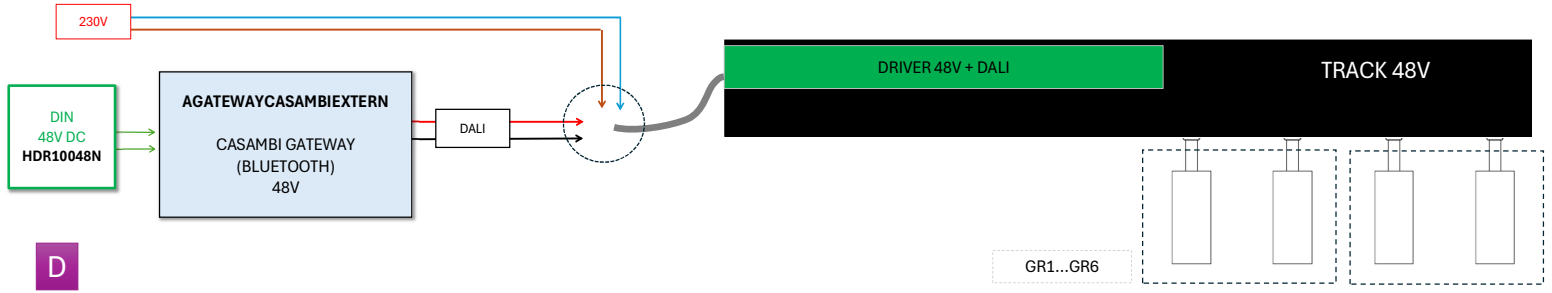

TRACK 48V : SCHEMA'S VOOR DALI DIMMEN

DALI DIMMEN **MET** DE MOGELIJKHEID OM ARMATUREN TE **GROEPEREN**.

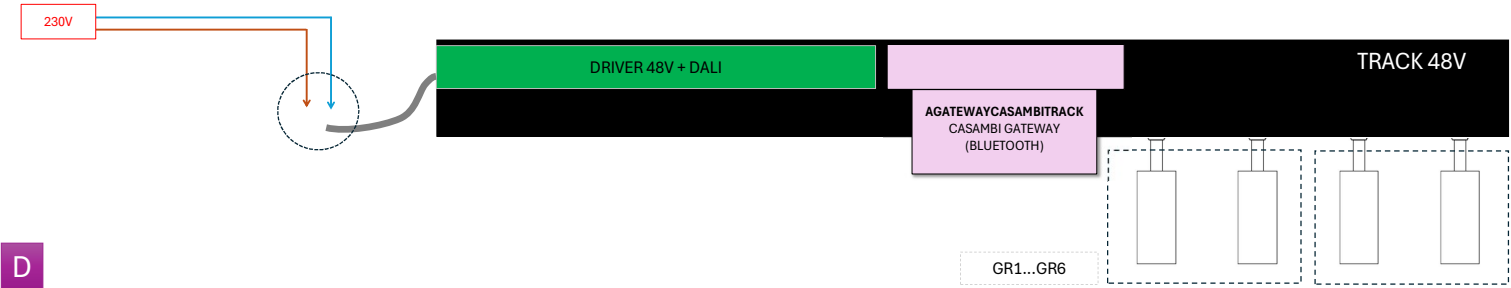

D

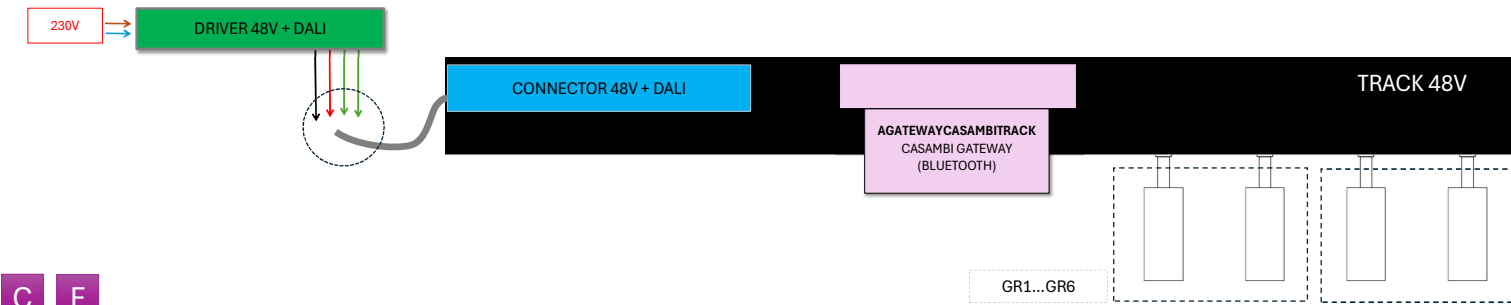

C F

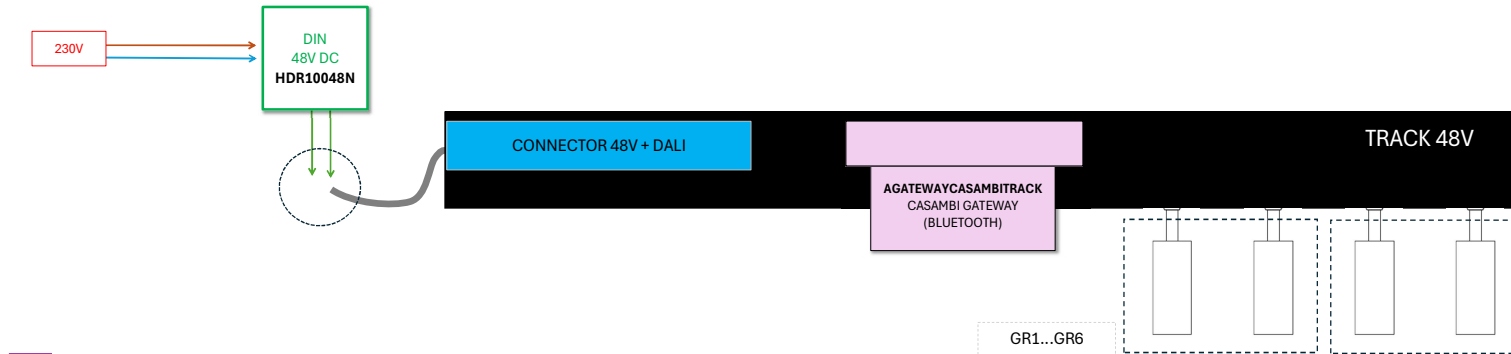

A B E